

AIKH45Q

L70
25°C

393,000 Hours

Amber Large Kitty Hawk Area, Wall, and Flood Light



Shown with "SF" Slipfitter Mounting Option.

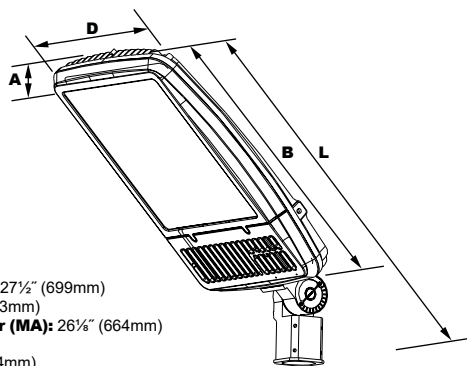

Dimensions

Width (D)	15 3/4" (400mm)
Length (B)	22" (559mm)
Height (A)	4" (102mm)

Length with Mount (L)	Kitty Hawk Arm (KA): 27 1/2" (699mm) Slipfitter (SF): 29 3/4" (743mm) Mounting Arm Adaptor (MA): 26 1/2" (664mm) Yoke (Y): 26 1/4" (667mm) Bracket (BR): 25 3/4" (654mm) Wall Mount Bracket (WM): 23 3/4" (604mm)
-----------------------	--

The Atlantic Amber AIKH45Q cut-off area, wall mounted or flood light luminaire is available with a wide choice of mounting configurations and IES Type III or V distributions or a 30° narrow beam designed to replace HID lighting systems up to 400w MH or HPS for wildlife or security applications requiring monochromatic AMBER light. LEDs operate between 585 and 595 nm, greater than 560nm required for wildlife protection. Typical lighting applications include retail centers, industrial parks, schools and universities, public transit and airports, office buildings and medical facilities. Mounting can be accomplished using ground attachment accessories and to heights of 16 to 35 feet based on light level and uniformity requirements.

Specifications and Features:

Housing:

Die Cast Aluminum Housing and Front Frame, Integral Heat Sinking and Driver Compartment. Photocell Adaptable. Nickel-Plated Stainless Steel Hardware.

Listing & Ratings:

CSA: Listed for Wet Locations, ANSI/UL 1598, 8750; IP66 Sealed LED Compartment.

Finish:

Textured Architectural Bronze Powdercoat Finish Over a Chromate Conversion Coating. Custom Colors Available Upon Request.

Lens:

Tempered Clear Flat Glass Lens

Mounting Options:

Mounts with Kitty Hawk Arm, Adjustable Slipfitter, 2 3/4" Diameter Mounting Arm Adapter, Yoke, Two-Piece Bracket or Wall Mount Bracket. (Factory Installed)

Amber LED:

Aluminum Boards

Wattage:

Array: 167.3w, System: 180w; (250-400w HID Equivalent)

Driver:

Electronic Driver, 120-277V, 50/60Hz or 347-480V, 50/60Hz; Less Than 20% THD and PF>0.90. Standard Internal Surge Protection 6kV. 0-10V Dimming Standard for a Dimming Range of 100% to 10%; Dimming Source Current is 150 Microamps.

Controls:

Fixtures Ordered with Factory-Installed Photocell or Motion Sensor Controls are Internally Wired for Switching and/or 1-10V Dimming Within the Housing. Remote Direct Wired Interface of 1-10V Dimming is Not Implied and May Not Be Available, Please Consult Factory. Fixtures are Tested with Atlantic Controls and May Not Function Properly With Controls Supplied By Others. Fixtures are NOT Designed for Use with Line Voltage Dimmers.

Warranty:

5-Year Warranty for -40°C to +50°C Environment.

Amber

Project Information:

Project Name:	Fixture Type:
Complete Catalog #:	Date:
Comments:	

Certification & Listings:



Order Information Example:		AIKH45Q1X167UAMCZSFSP						
AIKH45Q		1X167		AM	C			
Model	Beam	Wattage	Driver	CCT	Lens	Color	Mounting	Options
AIKH45Q =Amber Large Kitty Hawk Area, Wall, and Flood Light	C =NEMA 7Hx7V* F =NEMA 7Hx7V I =NEMA 4Hx4V* * Special Order, 6 Week Lead Time.	1X167 =167w	U =120-277V H =347-480V	AM =Amber	C =Standard Clear Flat Glass Lens	Z =Bronze C =Custom (Consult Factory)	KA =Kitty Hawk Arm SF = Slipfitter MA = Mounting Arm Adapter Y =Yoke BR =Two-Piece Swivel Bracket WM =Wall Mount NM =No Mount	SF =Single Fuse* DF =Double Fuse* SP =Surge Protection M1 =Motion Sensor, IR for mounting heights of 20ft to 35ft M2 =Motion Sensor, IR for mounting heights of 18ft or less R3 =3-Pin Twist Lock Photocell Receptacle R5 =5-Pin Twist Lock Photocell Receptacle R7 =7-Pin ANSI C136.41—2013 Twist Lock Photocell Receptacle S23 =Internal Microwave Sensor with Dimming for Mounting Heights of 35' or Less.* S43 =Microwave On/Off Motion Sensor for Mounting Heights of 8' to 19'.* *120-277V Models Only.

Accessories & Replacement Parts:

Mounting Accessories (Order Separately, Field Installed)	
AIKH40RPZ	Die-Cast Adaptor for 4" to 6" Round Poles, Bronze Powdercoat Finish. Use with AIKH45A Kitty Hawk Mounting Arm only.
AIKH40WMZ	Die-Cast Wall Mount Adaptor, Bronze Powdercoat Finish. Use with AIKH45A Kitty Hawk Mounting Arm only.
AIPTSB1SZ	Single Pole Tenon Spoke Bracket, 2 3/8" Horizontal Mounting Arm, Bronze Powdercoat Finish, Includes Hardware.
AIPTSB290SZ	Twin Pole Tenon Spoke Bracket, 2 3/8" Horizontal 90° Mounting Arms, Bronze Powdercoat Finish, Includes Hardware.
AIPTSB2180SZ	Twin Pole Tenon Spoke Bracket, 2 3/8" Horizontal 180° Mounting Arms, Bronze Powdercoat Finish, Includes Hardware.
AIPTSB390SZ*	Triple Pole Tenon Spoke Bracket, 2 3/8" Horizontal 90° Mounting Arms, Bronze Powdercoat Finish, Includes Hardware.
AIPTSB3120SZ*	Triple Pole Tenon Spoke Bracket, 2 3/8" Horizontal 120° Mounting Arms, Bronze Powdercoat Finish, Includes Hardware.
AIPTSB490SZ*	Quad Pole Tenon Spoke Bracket, 2 3/8" Horizontal 90° Mounting Arms, Bronze Powdercoat Finish, Includes Hardware.

*Non-stock item. Consult factory for lead time.



Accessories (Order Separately, Field Installed)	
AIP18131	Twist Lock Non-Shorting (Open) Cap Disconnects Service to Fixture for Temporary or Permanent Disabling (Fixture Always Off). IP65, 480V Maximum.
AIP18132	Twist Lock Shorting Cap Provides Fixed Service to Fixture (Fixture Always on). IP65, Rated Load 7200w Tungsten.
AIP18140	110-120VAC Instant Twist Lock Photocell
AIP18152	277VAC Time Delay Twist Lock Photocell
AIP18156	120-277VAC Universal Twist Lock Photocell
AIP18157	480VAC Time Delay Twist Lock Photocell. For 480V use only.
AIACCHSG1Z	Die Cast Accessory Housing for Installing Sensors or Other Lighting Controls, Bronze Powdercoat Finish
AIKH45GSZ	Aluminum Glare/House Side Shield, Bronze Powdercoat Finish, Includes Hardware.
AIKH45WG	Wire Guard, Stainless Steel Construction, Includes Hardware.
AIACCHSG3	Bronze UV-Stabilized Polycarbonate Housing for Installing Sensors, Includes Sensor Bracket and Gasket.

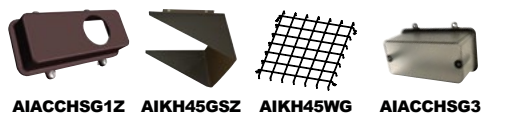

Replacement Parts (Order Separately, Field Installed)	
AIKH45GL	Tempered Clear Flat Glass Lens.
AIKH45AZ	Kitty Hawk Mounting Arm, Mounts Directly to Square Poles, Bronze Powdercoat Finish
AIFL73SFXZ	External Mount Slipfitter, Die Cast, Bronze Powdercoat Finish
AIALMAAZ	Pole Mounting Arm Adaptor, Fits 2 3/8" Arm, Includes Hardware, Bronze Powdercoat Finish
AIKH45YZ	Yoke, Stamped Heavy-Duty Steel, Bronze Powdercoat Finish
AIFL73BRZ	Two-Piece Swivel Bracket, Stamped Steel, Bronze Powdercoat Finish
AIWBR2Z	Wall Bracket, Heavy-Duty Stamped Steel, Bronze Powdercoat Finish, Includes Hardware.
AIP17117	Internal Microwave Sensor with Dimming, 120-277VAC, 50/60Hz. See AIP17117 Specification Page for Details.
AIP17123	Internally Mounted Microwave On/Off Motion Sensor for Mounting Heights of 8' to 19', 120-277VAC, 50/60Hz



Mounting Options:



AIKH45Q w/ Kitty Hawk Arm (KA)

Kitty Hawk Die-Cast Mounting Arm, Bronze Powdercoat Finish, Includes Hardware. Mounts Directly to Square Poles.



AIKH45Q w/ Pole Mounting Arm Adaptor (MA)

Die-Cast Adaptor for 2 3/4" Horizontal Mounting Arms, Bronze Powdercoat Finish, Includes Hardware.



AIKH45Q w/ Yoke (Y)

Stamped Heavy-Duty Steel Yoke, Bronze Powdercoat Finish, Includes Hardware.



AIKH45Q w/ "SF" External Mount Slipfitter (SF)

External Mount Die-Cast Adjustable Slipfitter for 2 3/4" Tenons, Bronze Powdercoat Finish, Includes Hardware.



AIKH45Q w/ Two-Piece Swivel Bracket (BR)

Two-Piece Stamped Steel Adjustable Bracket, Bronze Powdercoat Finish, Includes Hardware.





AIKH45Q w/ Wall Mount (WM)



Wall Bracket, Heavy-Duty Stamped Steel, Bronze Powdercoat Finish, Includes Hardware.

EPA (Effective Projected Area)

Shown with Large Kitty Hawk Arm mounting.

Configuration	EPA (Sq. Ft.)	Weight (Lbs.)
 1	1.00	33 Lbs

Configuration	EPA (Sq. Ft.)	Weight (Lbs.)
 2@180° Mount	2.00	66 Lbs
 2@90° Mount	1.36	66 Lbs

Configuration	EPA (Sq. Ft.)	Weight (Lbs.)
 3@90° Mount	2.20	99 Lbs
 3@120° Mount	2.00	99 Lbs

Configuration	EPA (Sq. Ft.)	Weight (Lbs.)
 4@90° Mount	2.20	132 Lbs

Photometric Data

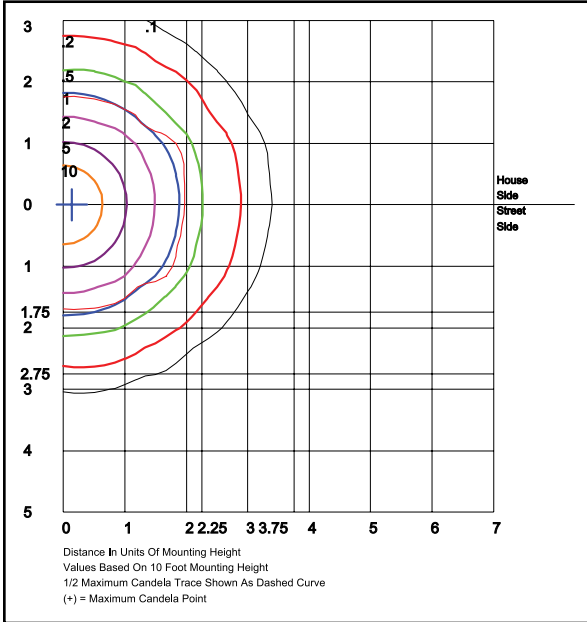

AIKH45QF1X167UAMC-
Type V
Grid in MH
MH=10 Feet

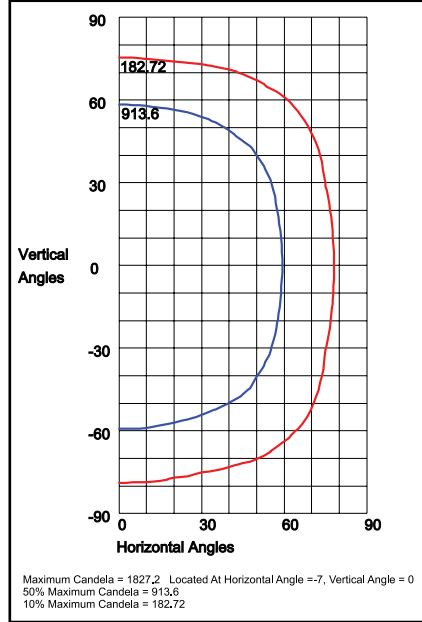

AIKH45QF1X167UAMC
115H x 110V, NEMA 7H x 7V

Spectral Chart

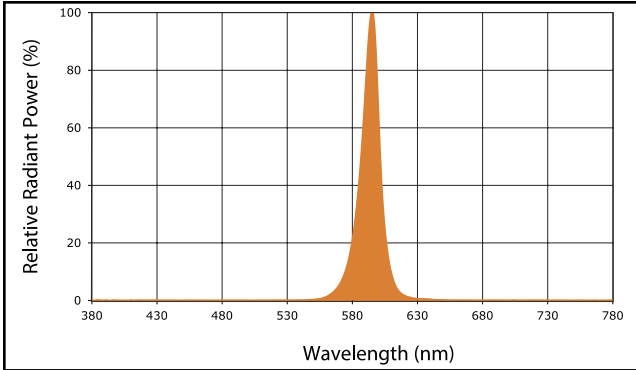

Photometric Performance

LED Board Watts	Drive Current (mA)	Input Watts	Optics	Amber LEDs				
				Lumens	LPW	B	U	G
Amber LED 167w	525	180	F Type V	5,717	32	2	2	1

LED Board Watts	Drive Current (mA)	Input Watts	Beam	Amber LEDs	
				Lumens	LPW
Amber LED 167w	525	180	F 115H x 110V, NEMA 7H x 7V	5,673	32